

**Surface or Inset Mount  
Side Track**

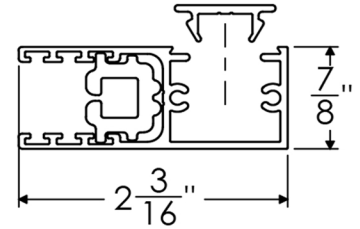

**Recessed Side Track  
(Preconstruction)**

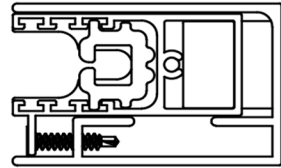

**"L" Mounting Bracket  
(optional)**

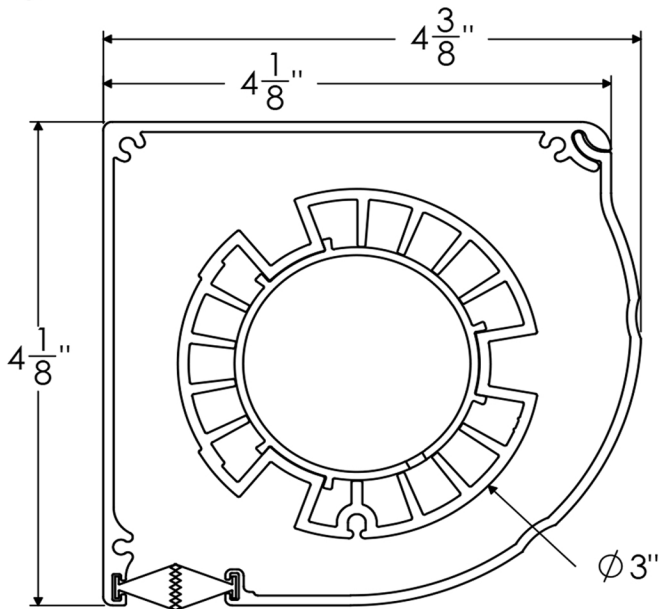
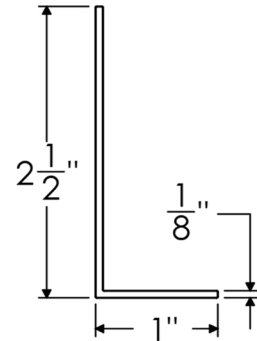

**Tall Hem Bar**

**Hem Bar**

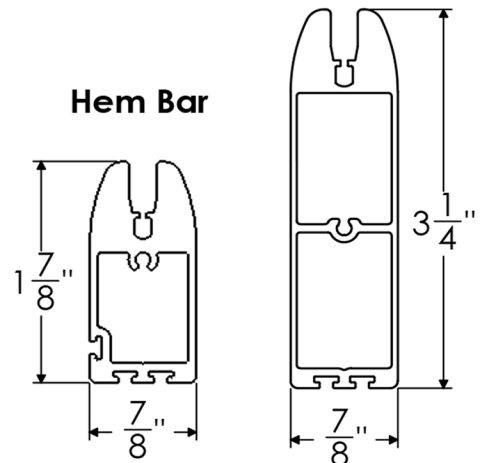

**SRS Series 4 Housing**